

产品使用说明书

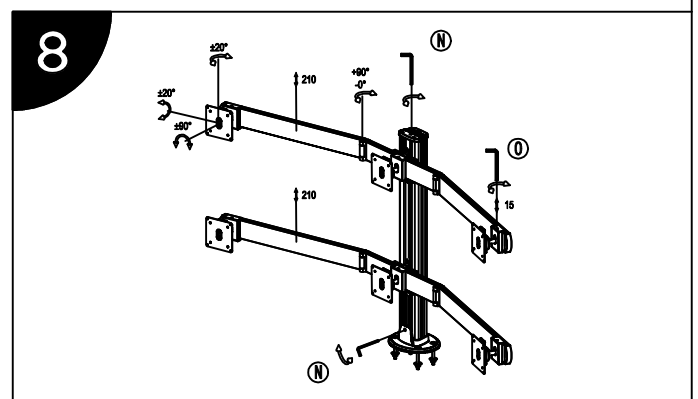

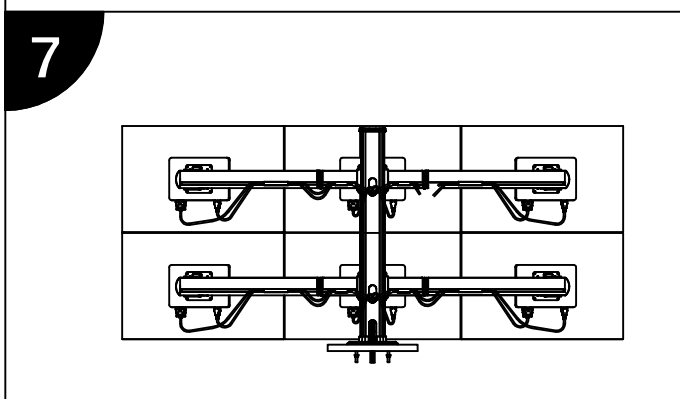

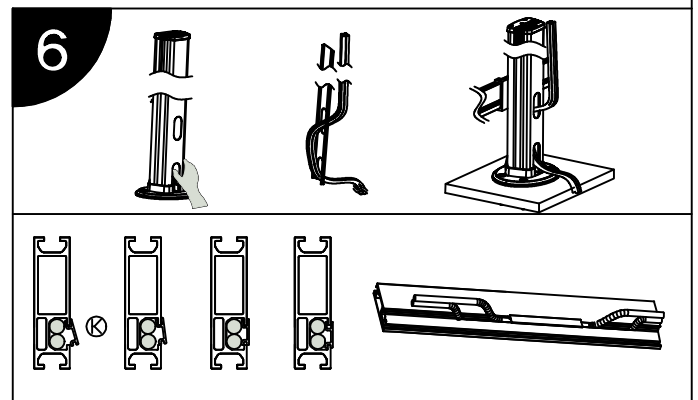

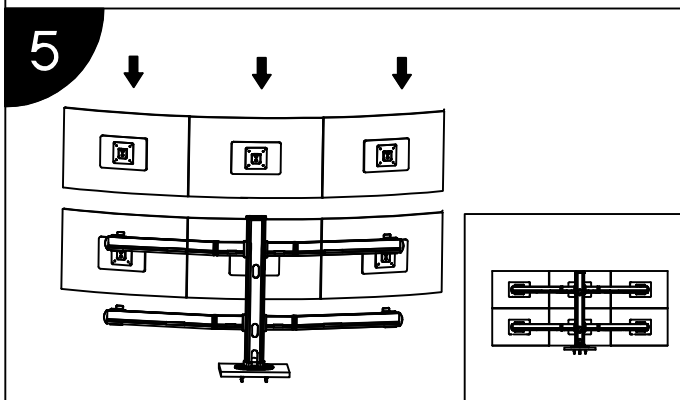
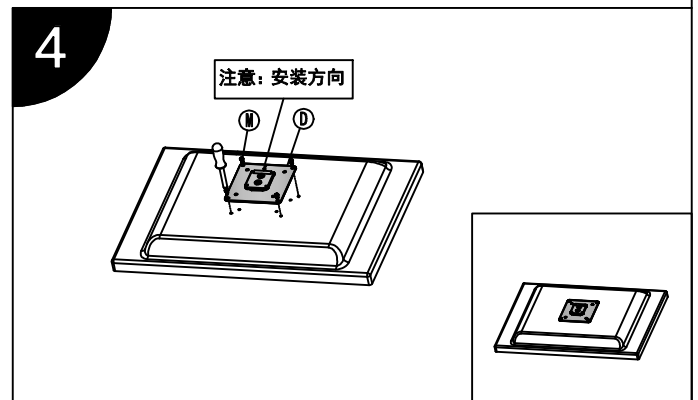
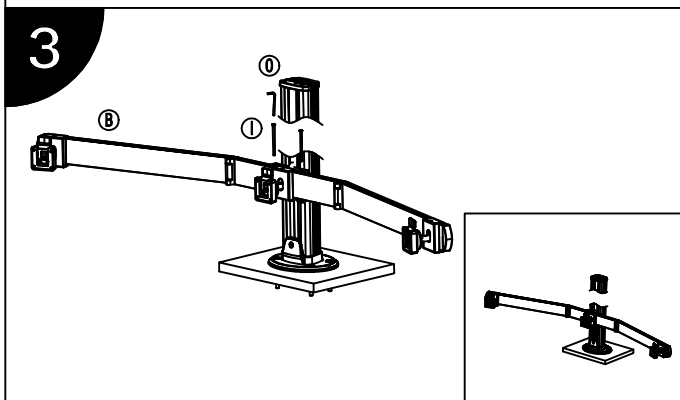
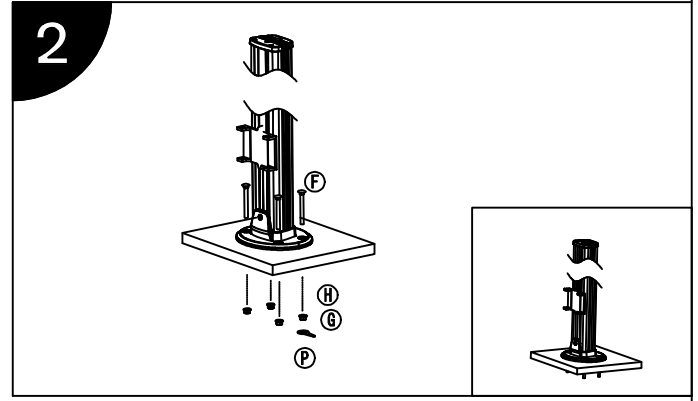
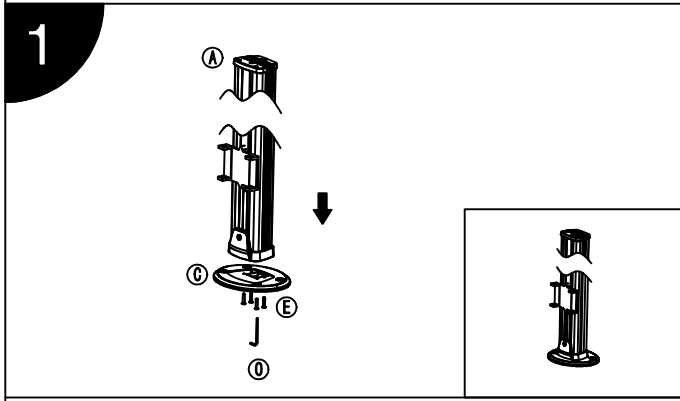







产品型号：CL600

安装步骤

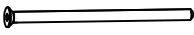

产品使用说明书

产品型号：CL600

标准配件			
序号	示图	规格	数量
A		CL0504	1
B		CL0103	2
C		CL0601	1
D		S100-1000	6
E		M5*25	4
F		M8*80	4
G		M8螺帽	4
H		M8垫片	4
I		FH-7991-5*80	4
/			
K		CL-AL-15-50	4
L		CL-AL-15-100	4
M		M4*12	24
N		M5	1
O		M3	1
P		E-FE-16	1