

产品使用说明书

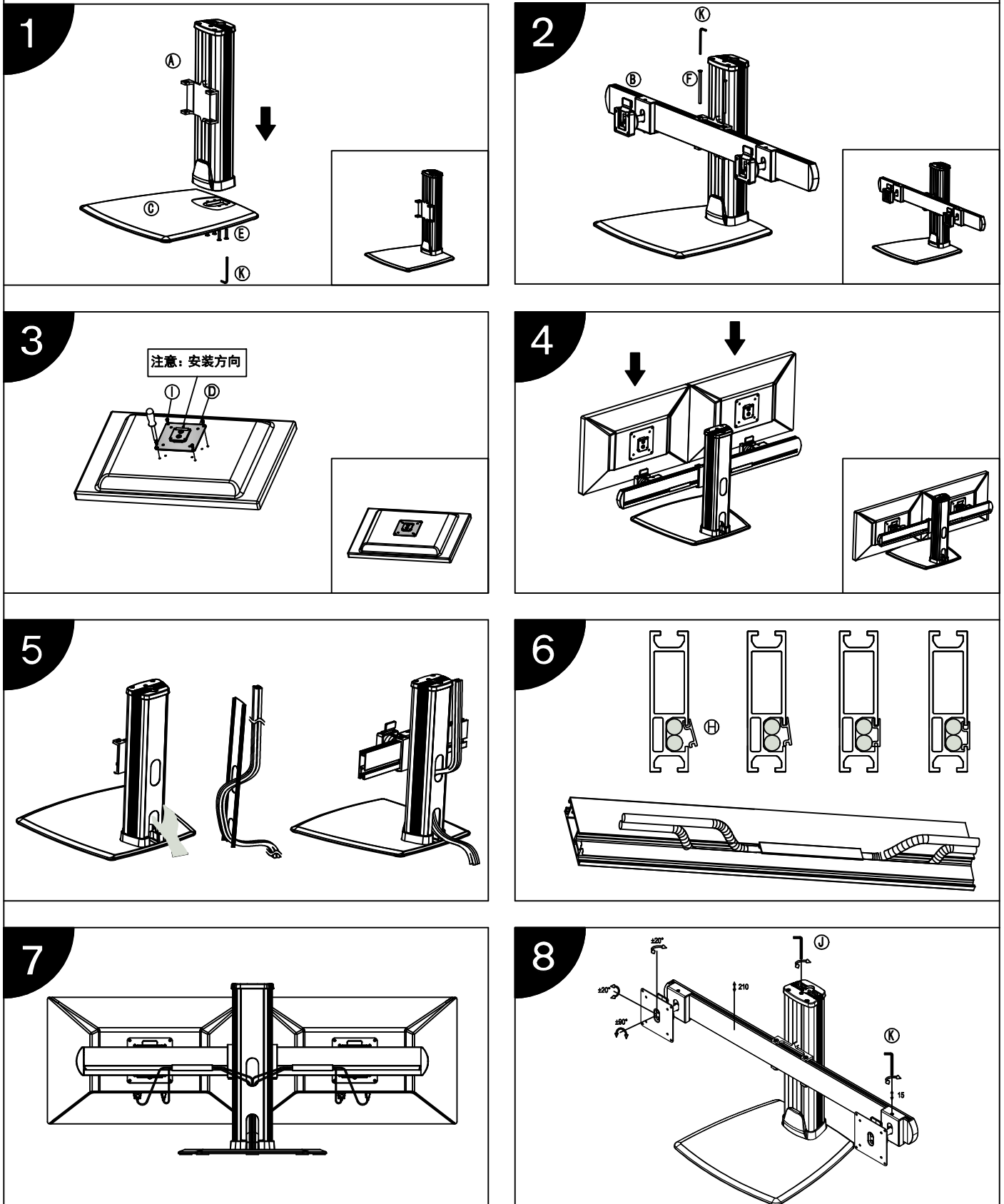





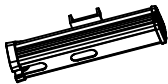
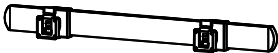

产品型号：CL204

安装步骤

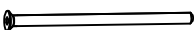

产品使用说明书

产品型号：CL204

标准配件			
序号	示图	规格	数量
A		CL0502	1
B		CL0102	1
C		CL0602	1
D		S100-1000	2
E		M5*25	4
F		FH-7991-5*80	2
/			
H		CL-AL-15-100	2
I		M4*12	8
J		M5	1
K		M3	1