

Product name: Slatrail mount arm

Model No.: D101

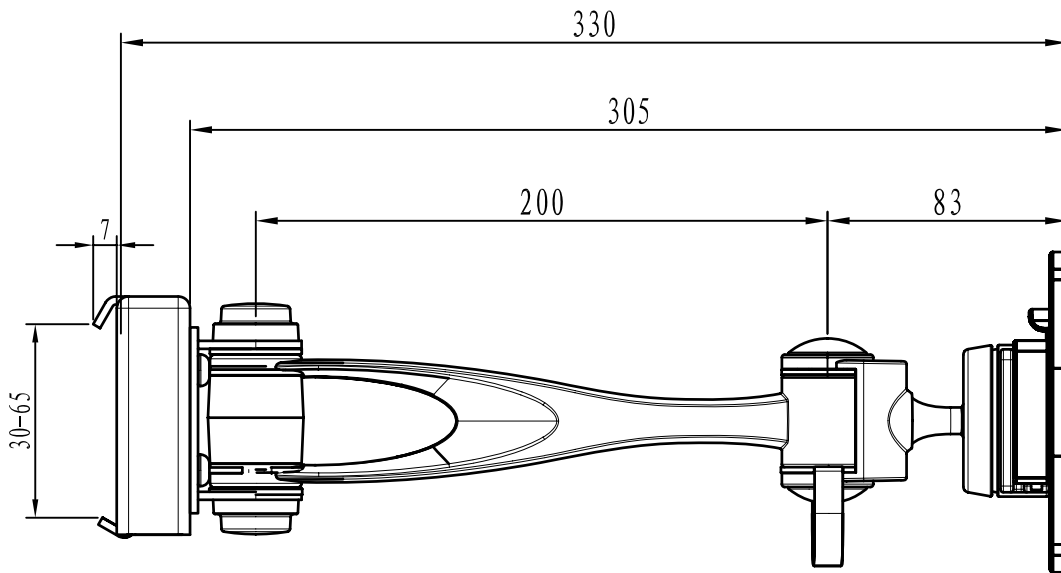

Product Features	Technical parameter										
<ul style="list-style-type: none"> <li>• Easy to adjust the monitor angle and position to satisfy the different view.</li> <li>• Multi-screens effect could be achieved in cooperation with the PF series, and independent assortment is feasible if in need.</li> </ul>											Slatrail mount
	LCD Size	Wt.Capacity(kg)	Lift(mm)	Tilt	Swivel	Pivot	VESA	Packing size(mm)	NW (kg)	GW(kg)	Installation range(mm)
	≤30"	13	—	±25°	±25°	360°	75*75 100*100	Inner:320*140*125 Outer:430*335*265 Inner/outer:6/1	Inner: 1.3 Outer:7.8	Inner: 1.55 Outer: 9.8	30-65



Product Dimensions

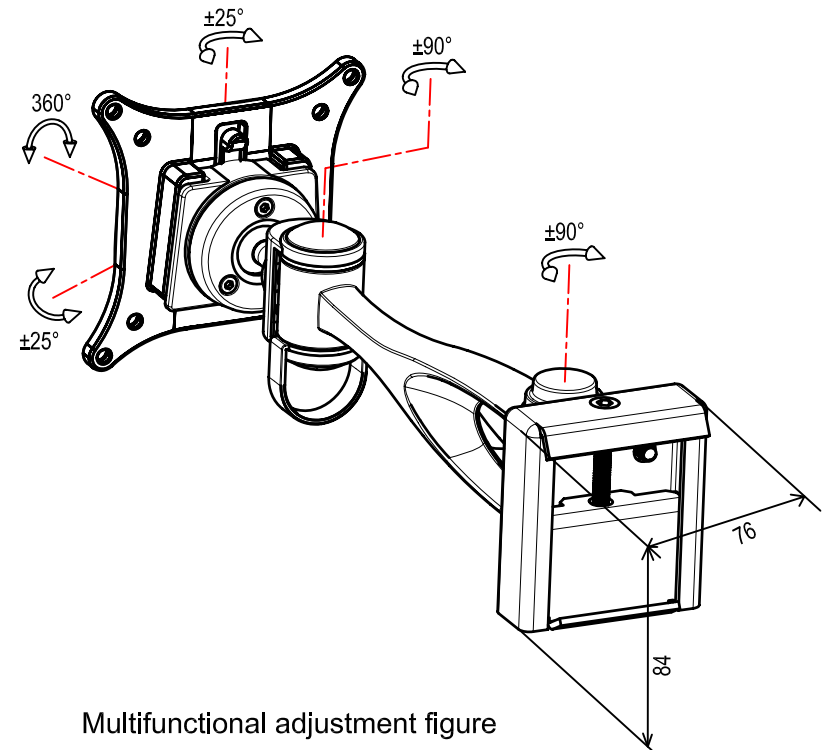

Multifunctional adjustment figure